

Connection hoses and cables	
Water hose:	✗
Waste water hose:	✗
Electric cable:	✗

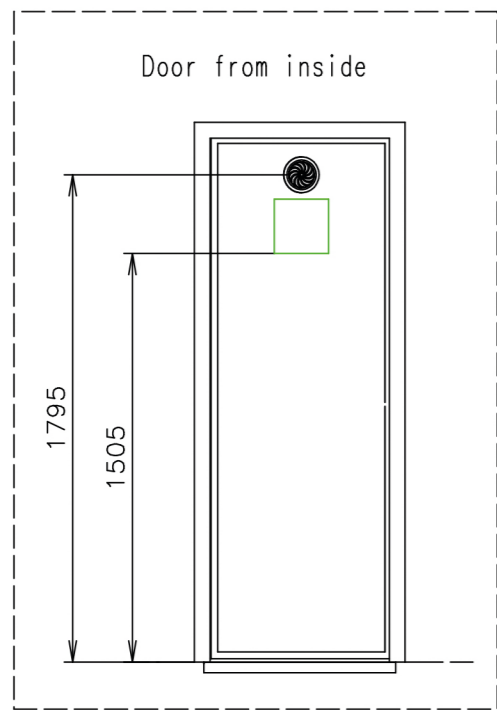
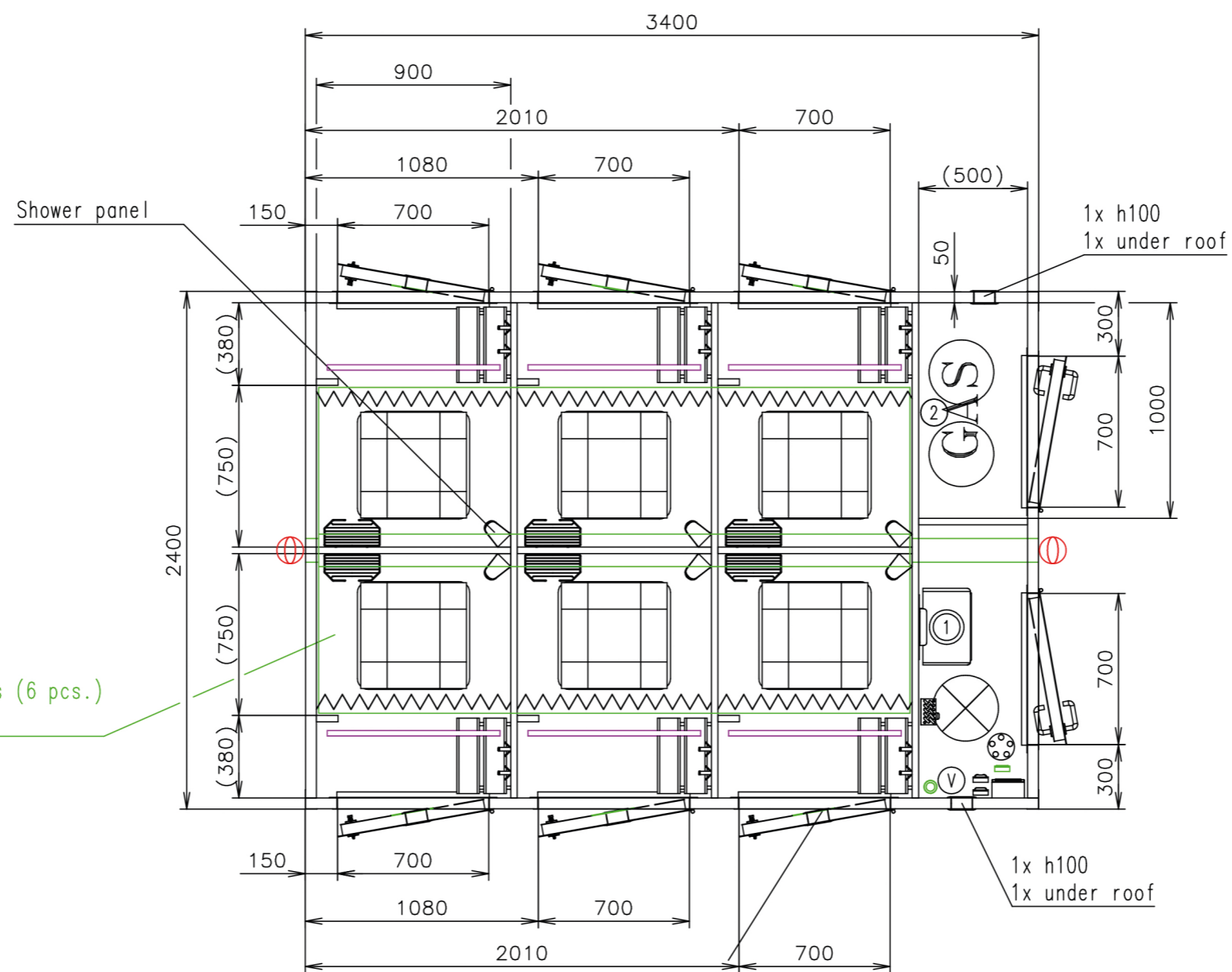

EWK frame - thickness 4mm

External doors - without cylinders

Door to showers - simple handle from both sides + lock + "roller" + sensor + LED RGB stripe (green/red), without cylinder

Notes: Without heatings in shower cabins Door to showers - automatic closing system

Interior height:	2200 mm	Total weight:	-
Color:	RAL 7042 (gray)	Tare weight-estimate:	1100 kg
Floor:	PVC Supreme plus 110	Centre of wheels from rear side:	-
Date:	1.12.2023	Wheels:	-









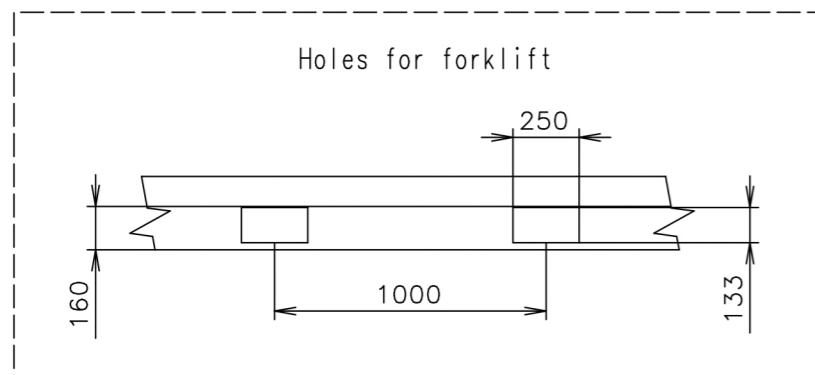
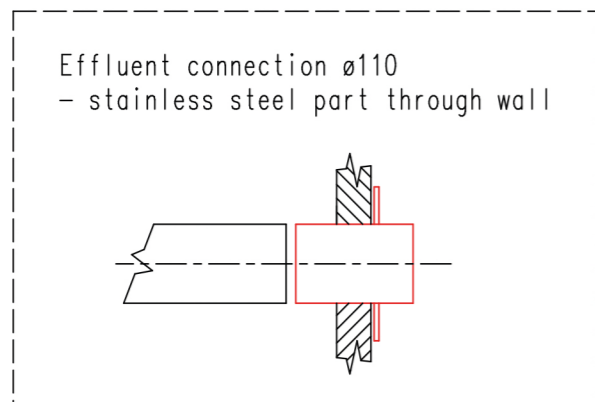









Sani Mobil

Drawing number:
4442-34-1 EWK_1/2 (Sprenger)

(Cabling and piping is not shown on the 3D views and drawings)

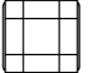
Connection hoses and cables	
Water hose:	✗
Waste water hose:	✗
Electric cable:	✗



-  Water connection 3/4" (through the wall) + filter + reduction valve
-  Electric connection (through the wall) (230V-16A)
-  2x effluent connection $\varnothing 110$ (through wall) - stainless steel part
-  Power point
-  Light switch
-  Switch board (1200 over floor)
-  Heating (200W)
-  LED stripe
-  LED sensorlight
-  Floor drain hole
-  Ventilation $\varnothing 120$
-  Shelf steel
-  Shower curtain
-  Clothes hanger
-  Roof window Dometic (400x400)
-  Mirror (200x200)
-  ① Gas water heater - Rinnai Infinity 28i
-  ② Gas regulator

Rubber buffers in each corner of both shorter sides

Fixing eyes for transport on both shorter sides

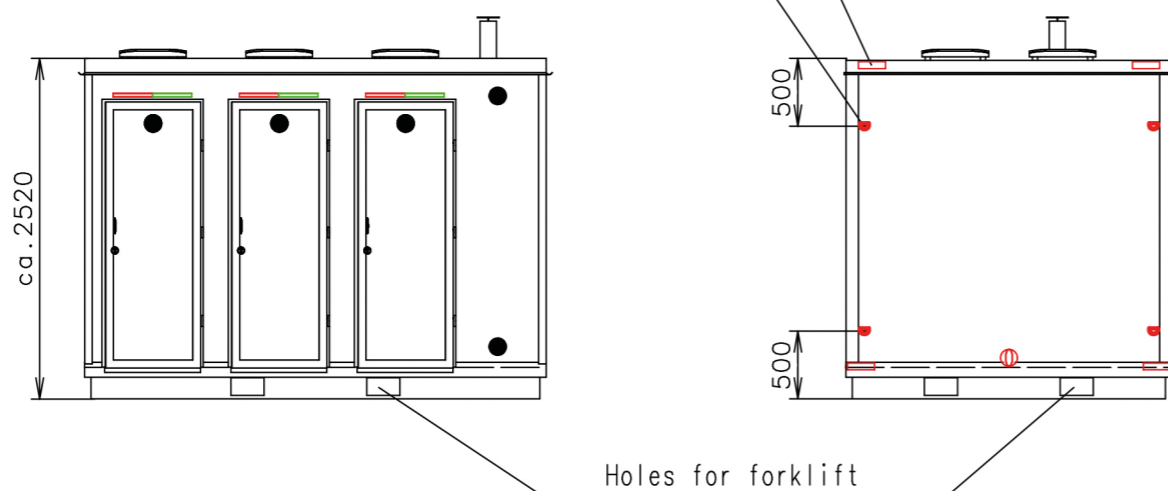

(Cabling and piping is not shown on the 3D views and drawings)

EWK frame - thickness 4mm

External doors - without cylinders

Door to showers - simple handle from both sides + lock + "roller" + sensor + LED RGB stripe (green/red), without cylinder

Notes:

Without heatings in shower cabins

Door to showers - automatic closing system

Interior height:	2200 mm	Total weight:	-
Color:	RAL 7042 (gray)	Tare weight-estimate:	1100 kg
Floor:	PVC Supreme plus 110	Centre of wheels from rear side:	-
Date:	1.12.2023	Wheels:	-

 **Sani Mobil**

Drawing number:
4442-34-1 EWK_2/2 (Sprenger)